

02

**DEDICATO A CHI FA DEL GELATO
UNA VERA ARTE**
*TO THOSE WHO MAKE GELATO
A REAL ART*

POZZETTI A GLICOLE / GLYCOL POZZETTI

POZZETTI VENTILATI / VENTILATED POZZETTI

MOBILE POZZETTI: JOY, VINTAGE, VIVÌ



02 LA PIÙ AMPIA GAMMA SUL MERCATO
THE WIDEST RANGE IN THE MARKET

GLYCOL POZZETTI COUNTERS

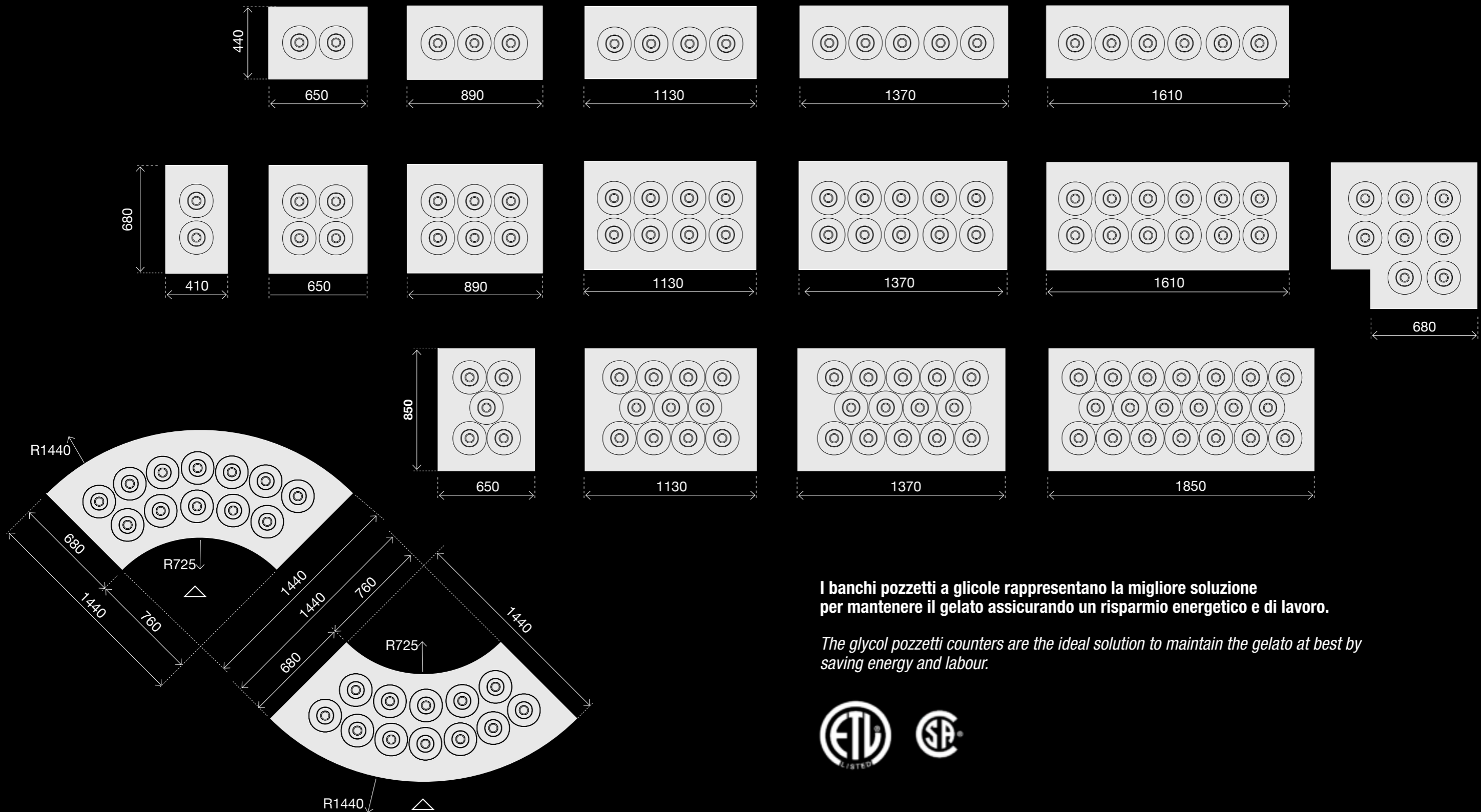

I banchi pozzetti a glicole rappresentano la migliore soluzione per mantenere il gelato assicurando un risparmio energetico e di lavoro.

The glycol pozzetti counters are the ideal solution to maintain the gelato at best by saving energy and labour.





02 **POZZETTI TRE FILE**
POZZETTI TRIPLE ROW
GLYCOL POZZETTI COUNTERS

TANTO GUSTO IN POCO SPAZIO:
FINO A 20 GUSTI IN UN MODULO DA L. 185 CM

A LOT OF TASTE IN LITTLE SPACE:
UNTIL 20 FLAVORS IN A MODULE 185 CM

5

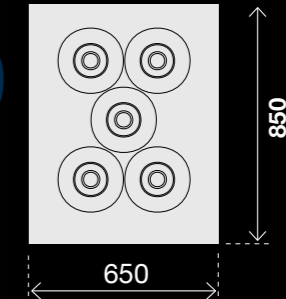

11

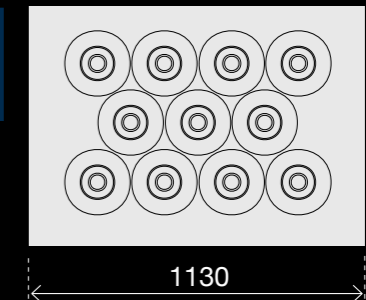

14

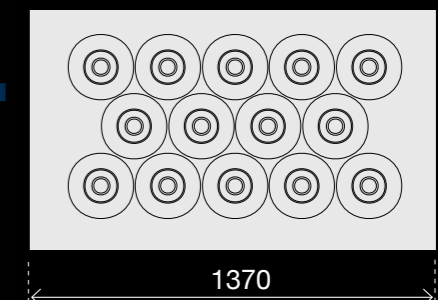

20

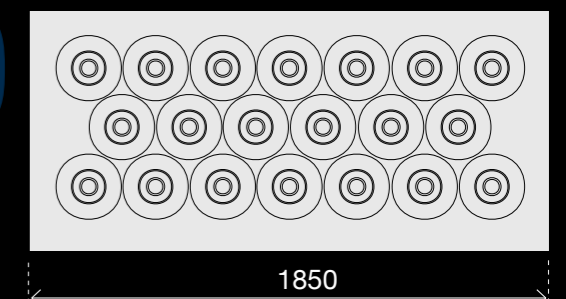

02 LA GELATERIA A MISURA DI CLIENTE
TAILORED MADE GELATO SHOP

GLYCOL POZZETTI COUNTERS

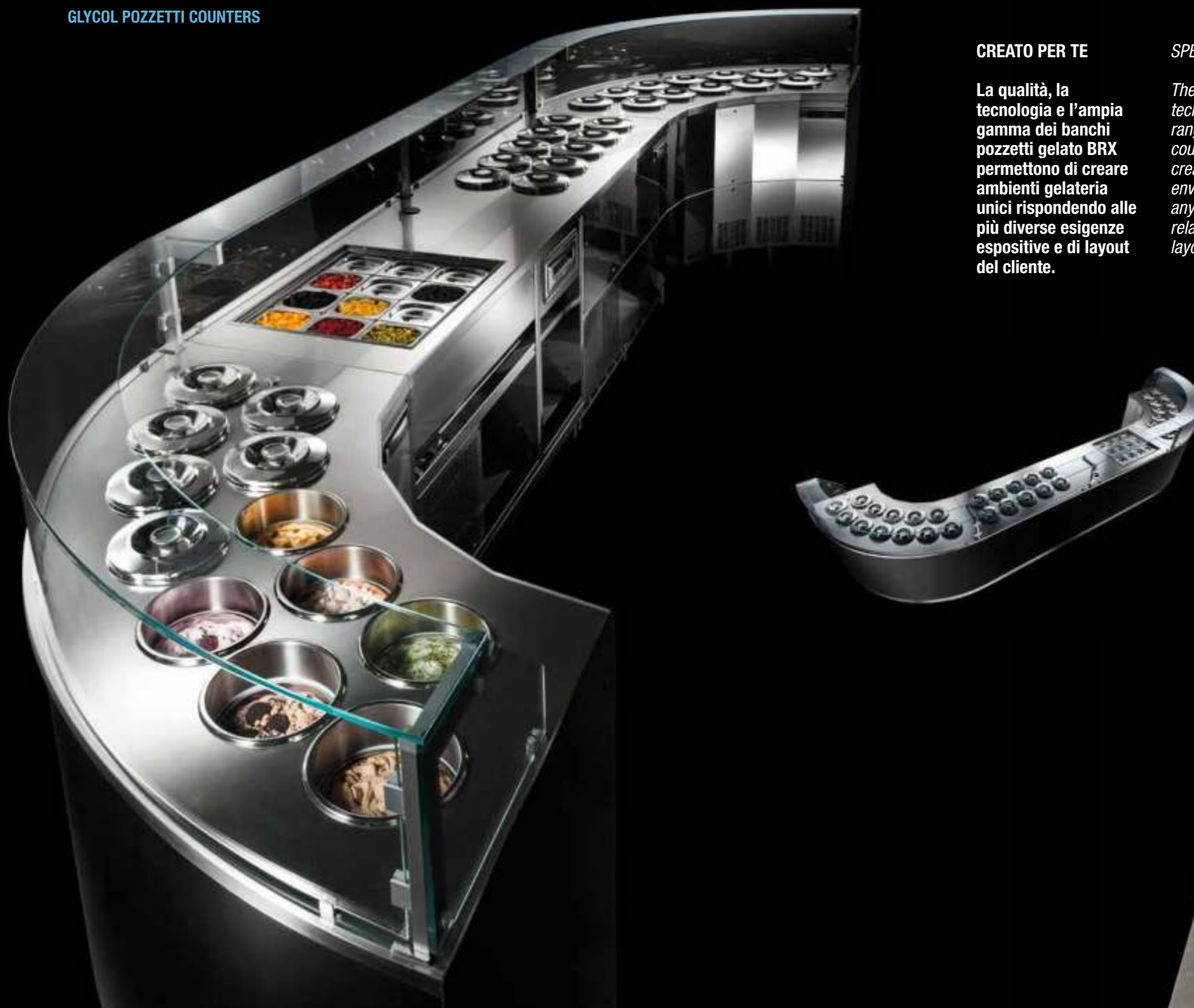

CREATO PER TE

La qualità, la tecnologia e l'ampia gamma dei banchi pozzetti gelato BRX permettono di creare ambienti gelateria unici rispondendo alle più diverse esigenze espositive e di layout del cliente.

SPECIFICALLY FOR YOU

The quality, the technology and the wide range of BRX pozzetti counters enable to create unique gelato environments meeting any customer's need related to display and layout.



02 **VANTAGGI TECNOLOGICI DI BRX**
BRX TECHNOLOGICAL ADVANTAGES

GLYCOL POZZETTI COUNTERS

DELTA 0

LA CARATTERISTICA CHE FA LA DIFFERENZA
THE FEATURE THAT MAKES THE DIFFERENCE

1

FACILITÀ DI SERVIZIO

Stessa temperatura
tra la parte superiore
e quella inferiore
del banco per
un'immediata
spatolabilità
del gelato della
carapina di riserva.

EASY OF USE

*Same temperature
throughout the upper and
lower carapina enabling
to scoop instantly the
gelato kept into the
carapina of the storage.*

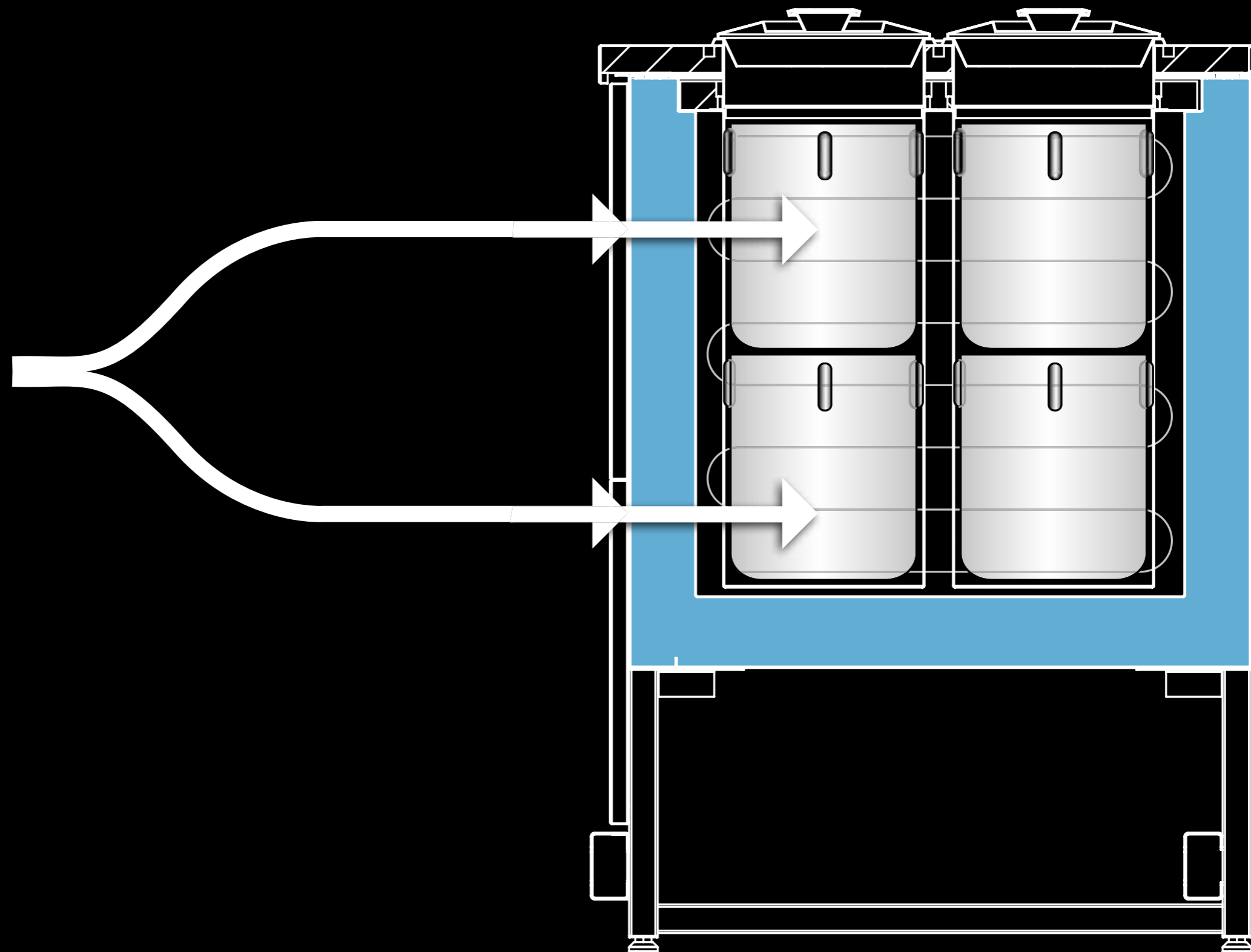

02 **VANTAGGI TECNOLOGICI DI BRX**
BRX TECHNOLOGICAL ADVANTAGES
GLYCOL POZZETTI COUNTERS

ENERGY SAVING

2

RISPARMIO ENERGETICO

Maggiore isolamento del banco grazie al più elevato spessore di coibentazione della vasca, 70 e 75 mm.

Maggiore efficienza energetica grazie al contatto diretto della serpentina in rame con il liquido refrigerante.

ENERGY SAVING

Bigger foam thickness of the counter 70 and 75 mm and consequently better insulation.

Great cooling efficiency: copper coil in direct contact with the glycol.

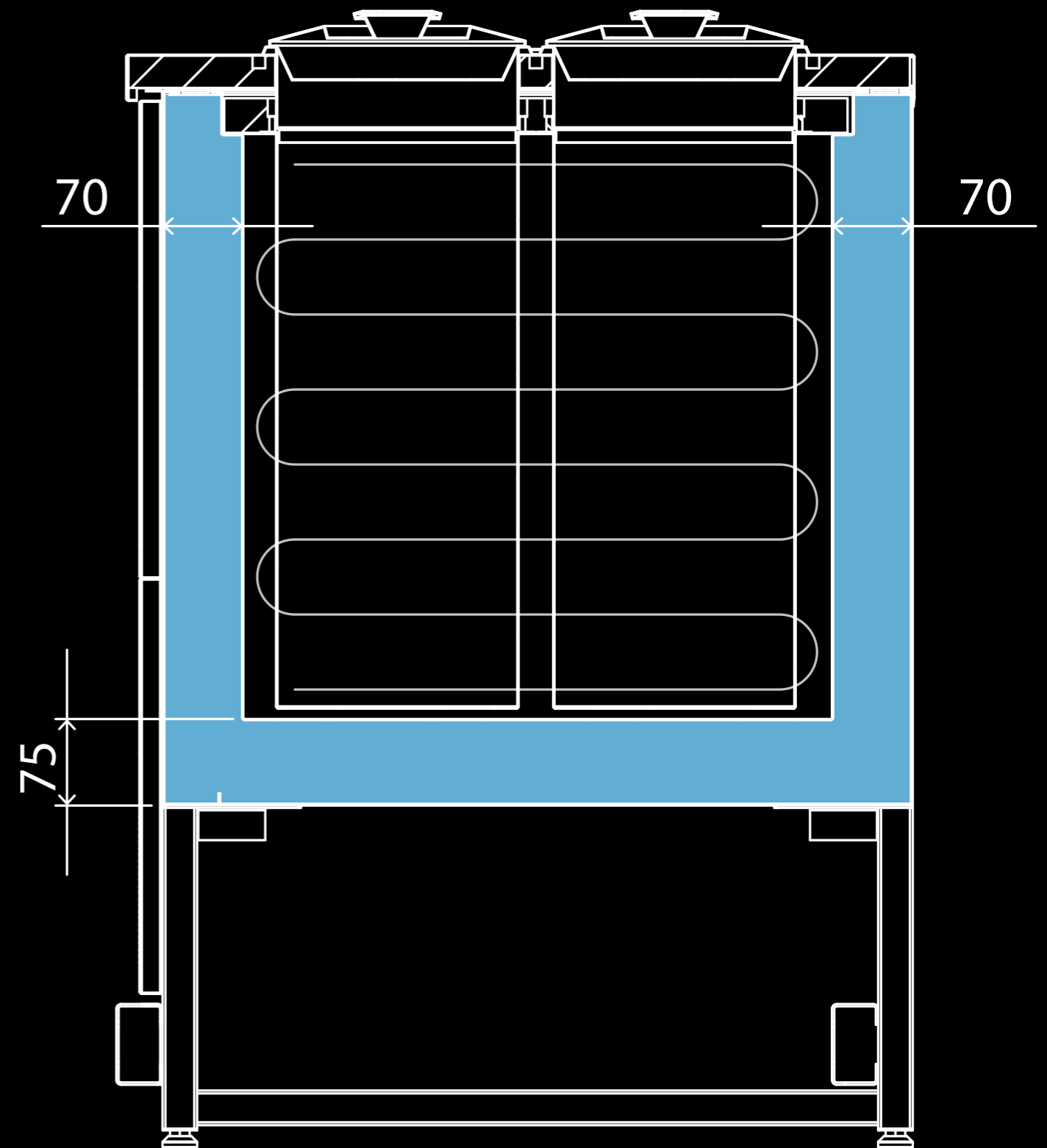

02 **VANTAGGI TECNOLOGICI DI BRX**
BRX TECHNOLOGICAL ADVANTAGES
GLYCOL POZZETTI COUNTERS

3

PIU GUSTI IN MENO SPAZIO

Sia l'unità condensatrice ad aria che ad acqua possono essere posizionate sotto la riserva.

MORE FLAVORS IN LESS SPACE

Both air-cooled and water cooled condensing units can be placed under the storage.

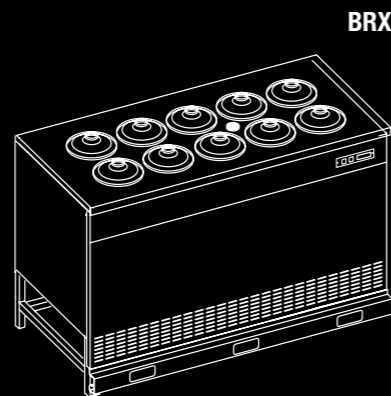

BRX ottimizza lo spazio del tuo locale.

BRX optimizes the space of your shop.

VS

ALTRI MARCHI
OTHER BRANDS

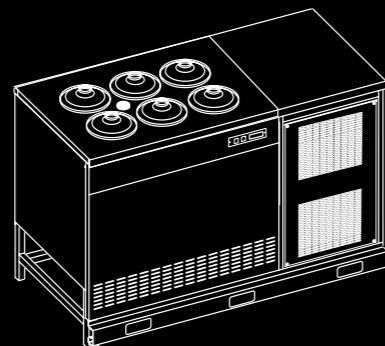

SPACE SAVING

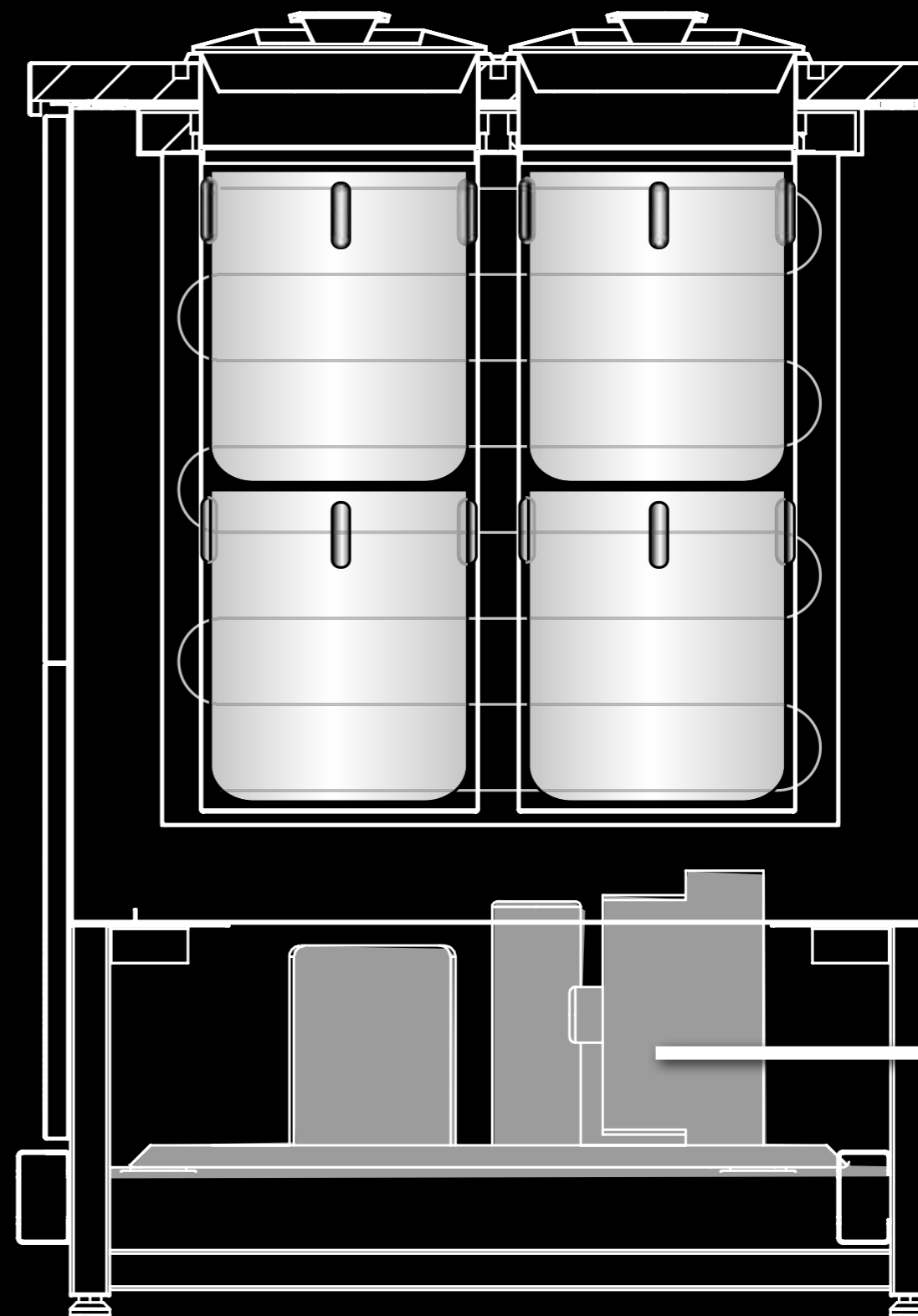

MOTORE
AD ARIA O AD ACQUA

AIR-COOLED
OR WATER-COOLED
MOTOR

02 PROGETTI SARTORIALI BESPOKE PROJECTS

GLYCOL POZZETTI COUNTERS

4

PER OGNI SPAZIO, ANCHE SU MISURA

Caratteristica di BRX è la realizzazione di progetti sartoriali avvalendosi di tecnologie d'avanguardia senza dimenticare la qualità e l'artigianalità della produzione.

FOR EVERY SPACE, EVEN CUSTOM MADE

BRX distinguishes itself for the realization of tailored projects using cutting-edge technologies without forgetting the quality and craftsmanship rooted in its tradition.

5

Top con sistema anticondensa anche per progetti su misura e top personalizzati.

condensation-proof heated top, available also for bespoke projects and personalized tops.



02 **VANTAGGI TECNOLOGICI DI BRX**
BRX TECHNOLOGICAL ADVANTAGES
GLYCOL POZZETTI COUNTERS

6 CARAPINA IN PLASTICA *PLASTIC CARAPINA*



“SISTEMA COORDINATO”
“COORDINATED SYSTEM”



**PUÒ ESSERE INSERITA
NELL'APPOSITA
CARAPINA IN ACCIAIO
DOTATA DI SISTEMA
ANTIROTAZIONE.**

*IT FITS THE DEDICATED
STAINLESS STEEL
CARAPINA EQUIPPED
WITH ANTI-SPIN SYSTEM*

**Per una produzione centralizzata lontana dai punti vendita.
Per vendere gelato artigianale a chi non lo produce.**

*Enabling a easy distribution from a central gelato production to the single shops.
Ideal tool to sell artisanal gelato to those who don't produce it.*

02 BANCHI POZZETTI VENTILATI VENTILATED POZZETTI COUNTERS

VENTILATED POZZETTI COUNTERS



BRX produce anche banchi pozzetti ventilati da 4 a 12 gusti, disponibili in moduli lineari, con e senza riserva.

BRX also manufactures ventilated pozzetti counters from 4 up to 12 flavors, available in linear modules, with and without storage.

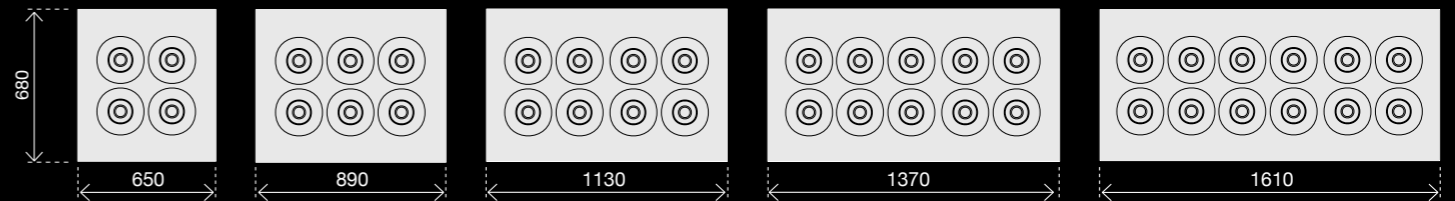

TECHNOLOGY

TOP CON SISTEMA ANTICONDENSA, ANCHE PER PROGETTI SU MISURA E TOP PERSONALIZZATI.

CONDENSATION-PROOF HEATED TOP, AVAILABLE ALSO FOR BESPOKE PROJECTS AND PERSONALIZED TOPS.

VASCA INTERNA REALIZZATA IN ACCIAIO INOX AISI 304.

INNER STRUCTURE REALIZED IN STAINLESS STEEL AISI 304.

CARAPINA CON SISTEMA ANTIROTAZIONE PER UNA MAGGIORE PRATICITÀ DI SERVIZIO.

CARAPINA WITH ANTI-SPIN SYSTEM.

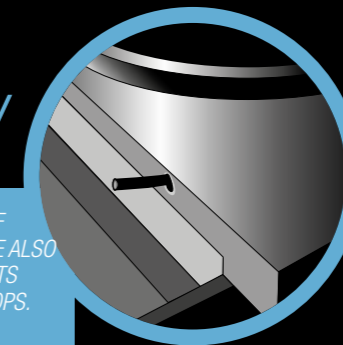

ENERGY SAVING

MAGGIORE ISOLAMENTO DEL BANCO GRAZIE AL PIÙ ELEVATO SPESSORE DI COIBENTAZIONE DELLA VASCA, 70 E 75 MM.

BIGGER FOAM THICKNESS OF THE COUNTER 70 AND 75 MM AND CONSEQUENTLY BETTER INSULATION.

SPACE SAVING

RISPARMIO DI SPAZIO: SIA L'UNITÀ CONDENSATRICE AD ARIA CHE AD ACQUA POSSONO ESSERE POSIZIONATE SOTTO LA RISERVA.

SPACE SAVING: BOTH AIR-COOLED AND WATER-COOLED CONDENSING UNITS CAN BE PLACED UNDER THE STORAGE.



SOLUZIONI MOBILI CON TUTTA LA TECNOLOGIA DI UN POZZETTO PROFESSIONALE

02 *MOBILE SOLUTIONS WITH FULL TECHNOLOGY
OF A PROFESSIONAL POZZETTI*

MOBILE POZZETTI

Pensati non solo per gelaterie ma anche per creare corner gelati in ristoranti, hotel, pasticcerie, bar e caffetterie, chioschi, aree di passeggio, eventi e catering.

Intended not only for ice cream parlours but also to create gelato corners in restaurants, wine bars, hotels, pastry shops, cafe'-bars, kiosks, walking areas, events and caterings.



02 **NUOVA SOLUZIONE SMART DI BRX**
NEW BRX SMART SOLUTION

JOY

JOY

CON RISERVA
WITH STORAGE

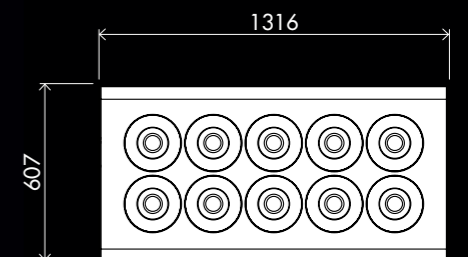
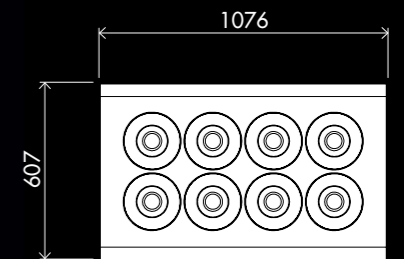
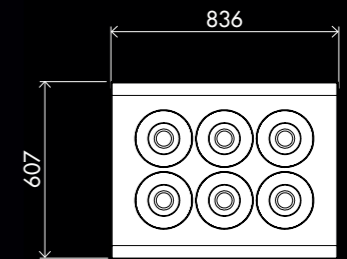
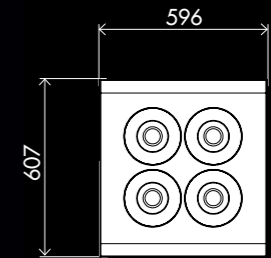

02 IL GELATO DI QUALITÀ SU RUOTE
MOBILE SOLUTION FOR QUALITY GELATO

VINTAGE

vintage
POZZETTO
High Quality



VINTAGE

Disponibile nei moduli 4, 6, 8 e 10 gusti, con e senza la riserva. È possibile personalizzare il banco scegliendo qualsiasi colore tra la gamma dei laccati RAL.

VINTAGE

Available in the modules 4, 6, 8 and 10 flavors, with and without storage. It is possible to personalize the counter choosing any color from the RAL lacquering colors.



02 IL GELATO SU RUOTE DI QUALITÀ MOBILE SOLUTION FOR QUALITY GELATO

VINTAGE

Disponibile sia in versione a glicole che ventilata, contiene le stesse caratteristiche tecniche di qualità della nostra gamma professionale di pozzetti gelato.

Available both glycol and ventilated cooling, it contains the same high-quality technical features of our professional range of pozzetti gelato.



Tutti i nostri pozzetti mobile possono essere personalizzati.

All our mobile pozzetti can be personalized with stickers.

CON RISERVA
WITH STORAGE

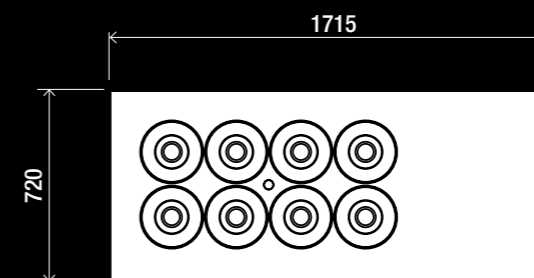
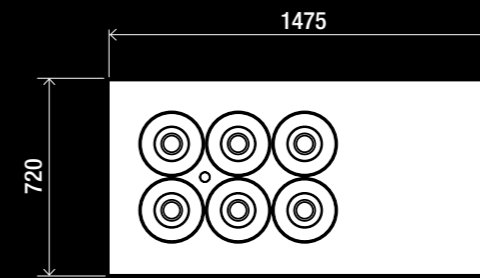
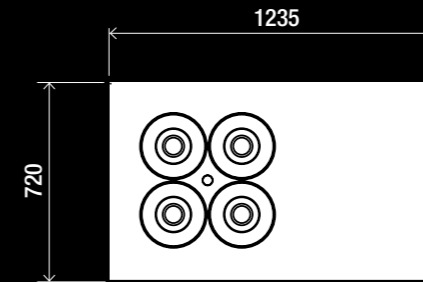

SENZA RISERVA
WITHOUT STORAGE

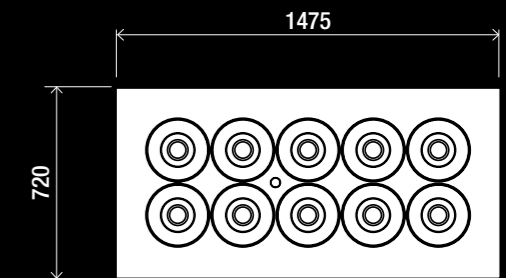
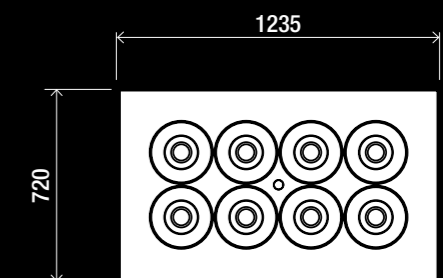
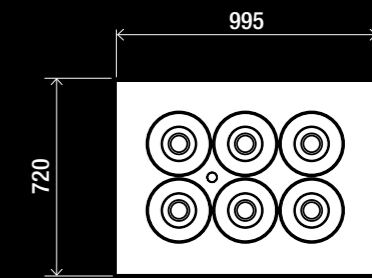
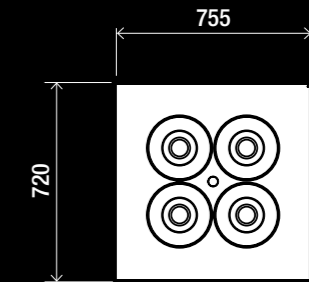

02 IL GELATO SU RUOTE DI QUALITÀ
MOBILE SOLUTION FOR QUALITY GELATO

vivi

Vivi
POZZETTO
gelato con savoir faire



Disponibile sia in versione a glicole che ventilata, contiene le stesse caratteristiche tecniche di qualità della nostra gamma professionale di pozzetti gelato.

Available both glycol and ventilated cooling, it contains the same high-quality technical features of our professional range of pozzetti gelato.

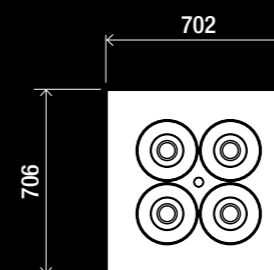

SENZA RISERVA
WITHOUT STORAGE

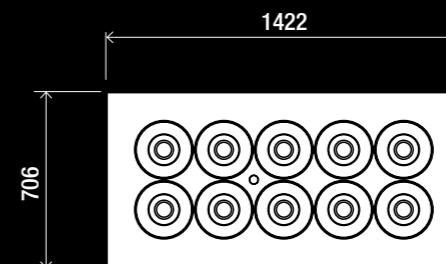
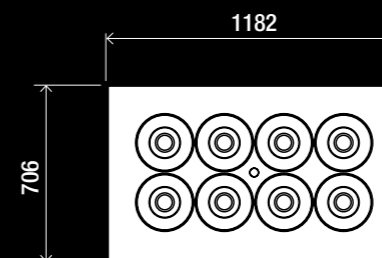
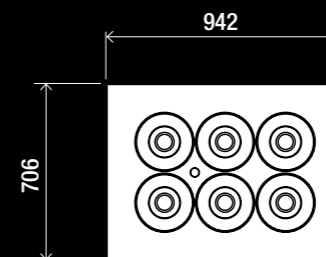

02 MODULI E MISURE RANGE AND SIZES

POZZETTI

SEZIONI
SIDE VIEWS

> CON RISERVA GLICOLE
WITH STORAGE UNIT- GLYCOL

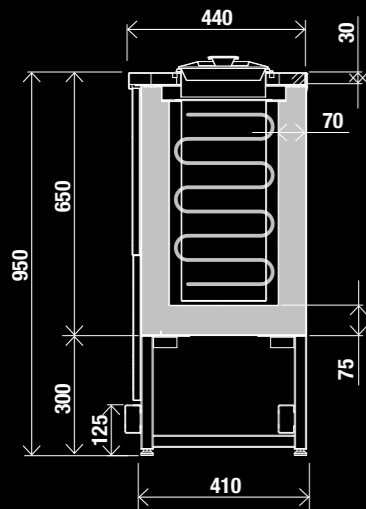

> SENZA RISERVA GLICOLE
WITHOUT STORAGE UNIT- GLYCOL

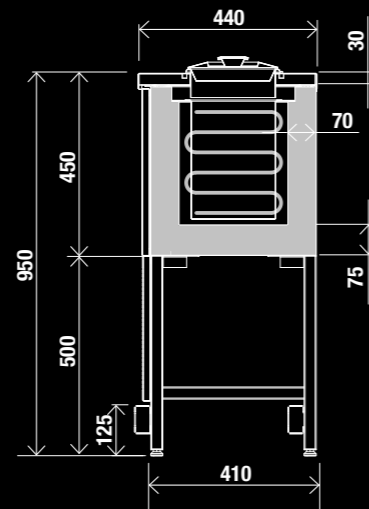

SEZIONI
SIDE VIEWS

> CON RISERVA VENTILATO
WITH STORAGE UNIT- VENTILATED

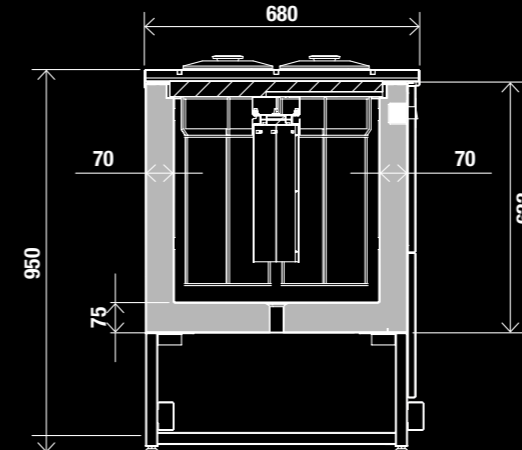

> SENZA RISERVA VENTILATO
WITHOUT STORAGE UNIT- VENTILATED

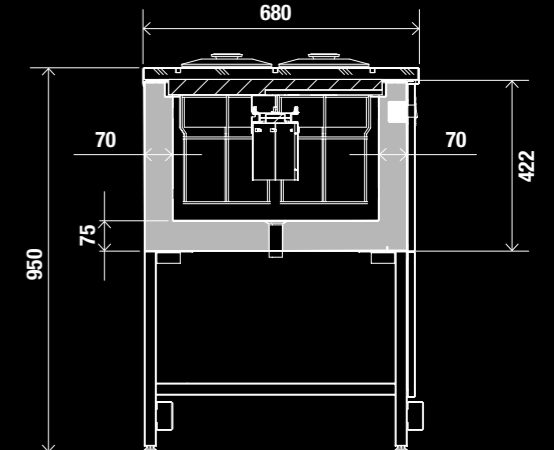

MOBILE POZZETTI

SEZIONI
SIDE VIEWS

JOY

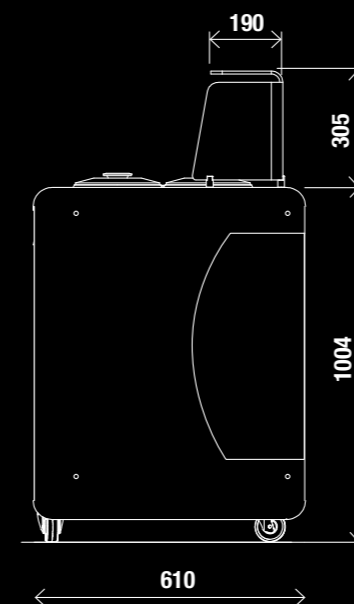

VINTAGE

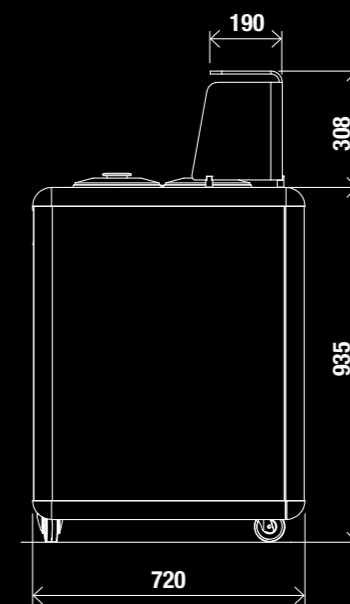

VIVI

